

# Le Reti nelle Scuole



L'accesso a  
Internet  
in reti  
complesse



Noi ...  
Sappiamo dove mettere le mani!



# Chi siamo



## Topics

Chi Siamo  
Esempi  
Ambiti  
Funzioni

### **Core Competences:**

Reti informatiche  
complesse

### **Certificazioni:**

- Mikrotik
- Allied Telesis
- Snom
- Watchguard
- Zyxel
- Cisco
- VMWare
- ecc

# Esempi di Splash Page 1/2

hotspot.alunni/login?dst=http%3A%2F%2Fdetectportal.firefox.com%2Fsuccess.txt

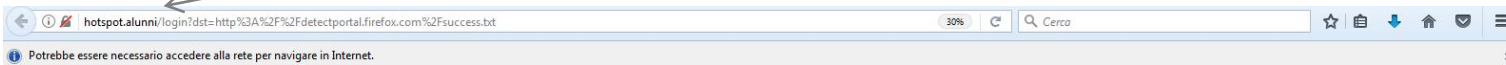

## Topics

- Chi Siamo
- Esempi
- Ambiti
- Funzioni



**istituto  
comprensivo  
D'AOSTA  
Ottaviano**



**Tutti gli usi della parola a tutti,  
non perché tutti siano artisti,  
ma perché nessuno sia schiavo.  
(G.Rodari)**

Attenzione di accedere per utilizzare il servizio Internet-Internet

Utente

Password

Powered by **ELMETEL**



# Esempi di Splash Page 2/2

Topics

Chi Siamo  
Esempi  
Ambiti  
Funzioni

Personalizzazione  
pagina di  
autenticazione

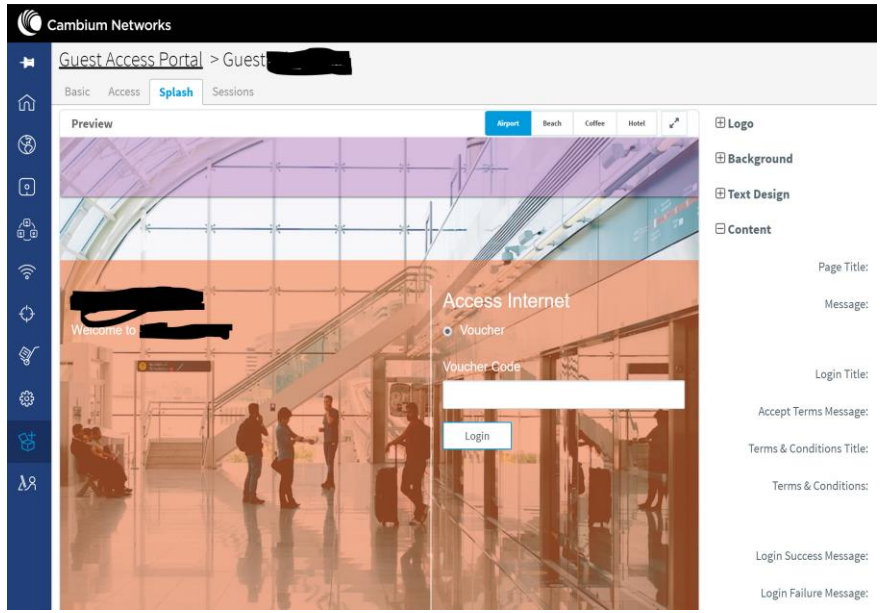



# Esempio topologia Rete

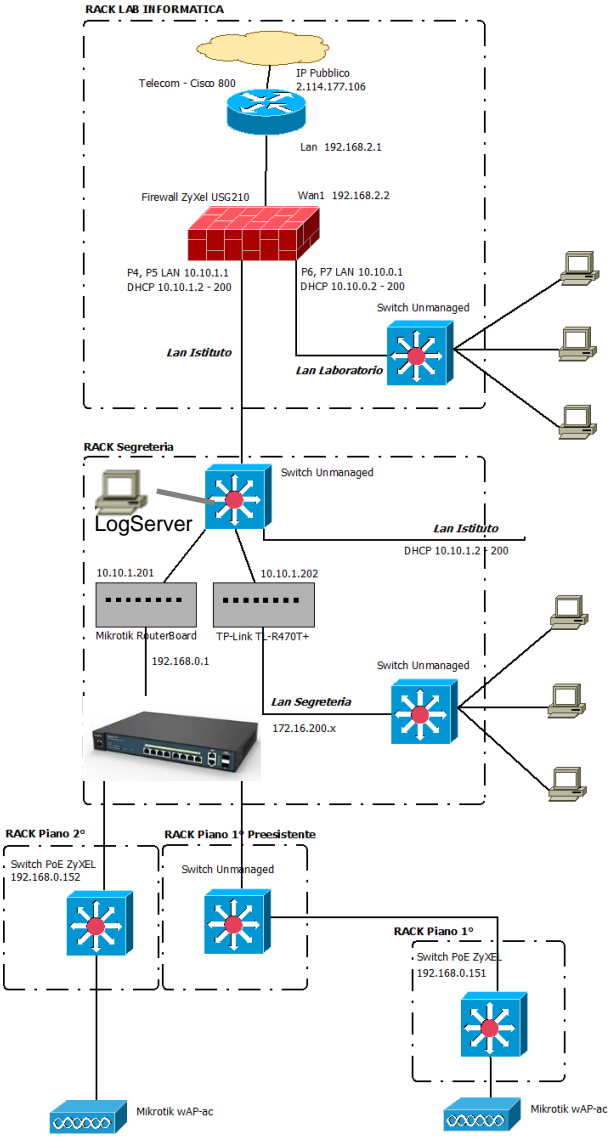

Topics

- Chi Siamo
- Esempi
- Ambiti
- Funzioni



# Esempio topologia Zoom 1

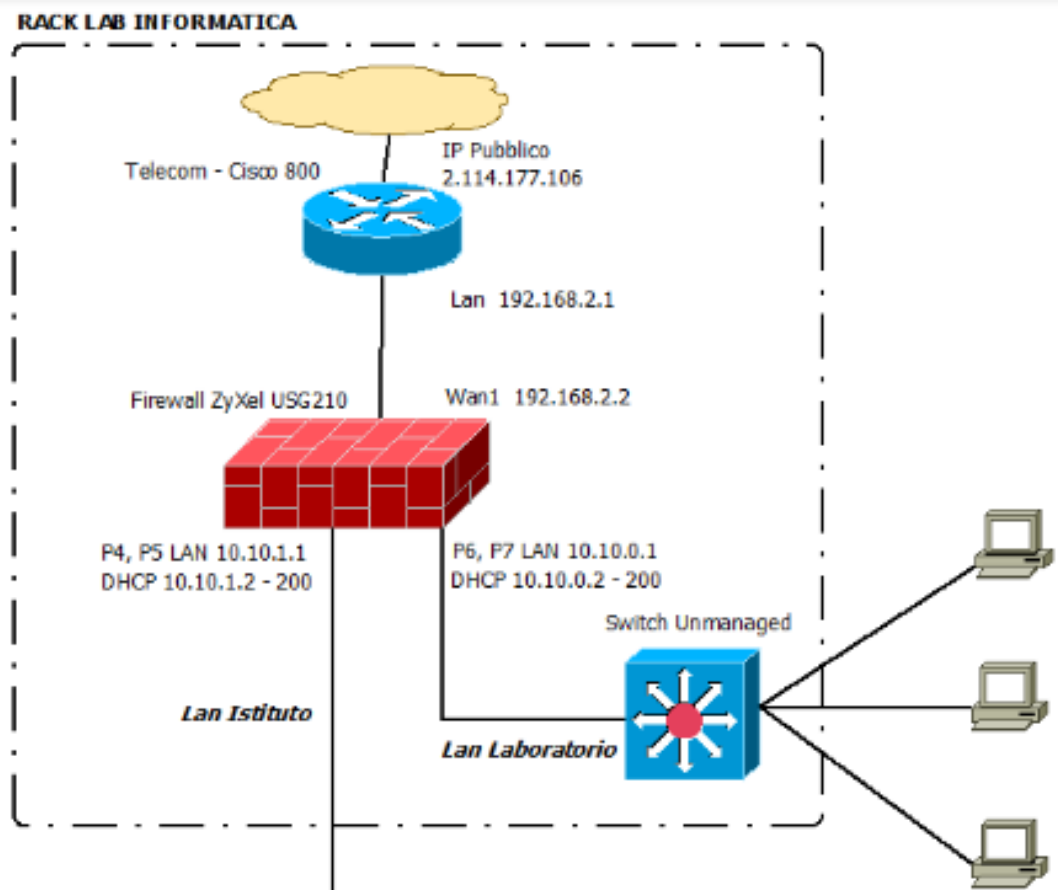

Topics

Chi Siamo  
Esempi  
Ambiti  
Funzioni



# Esempio topologia Zoom 2

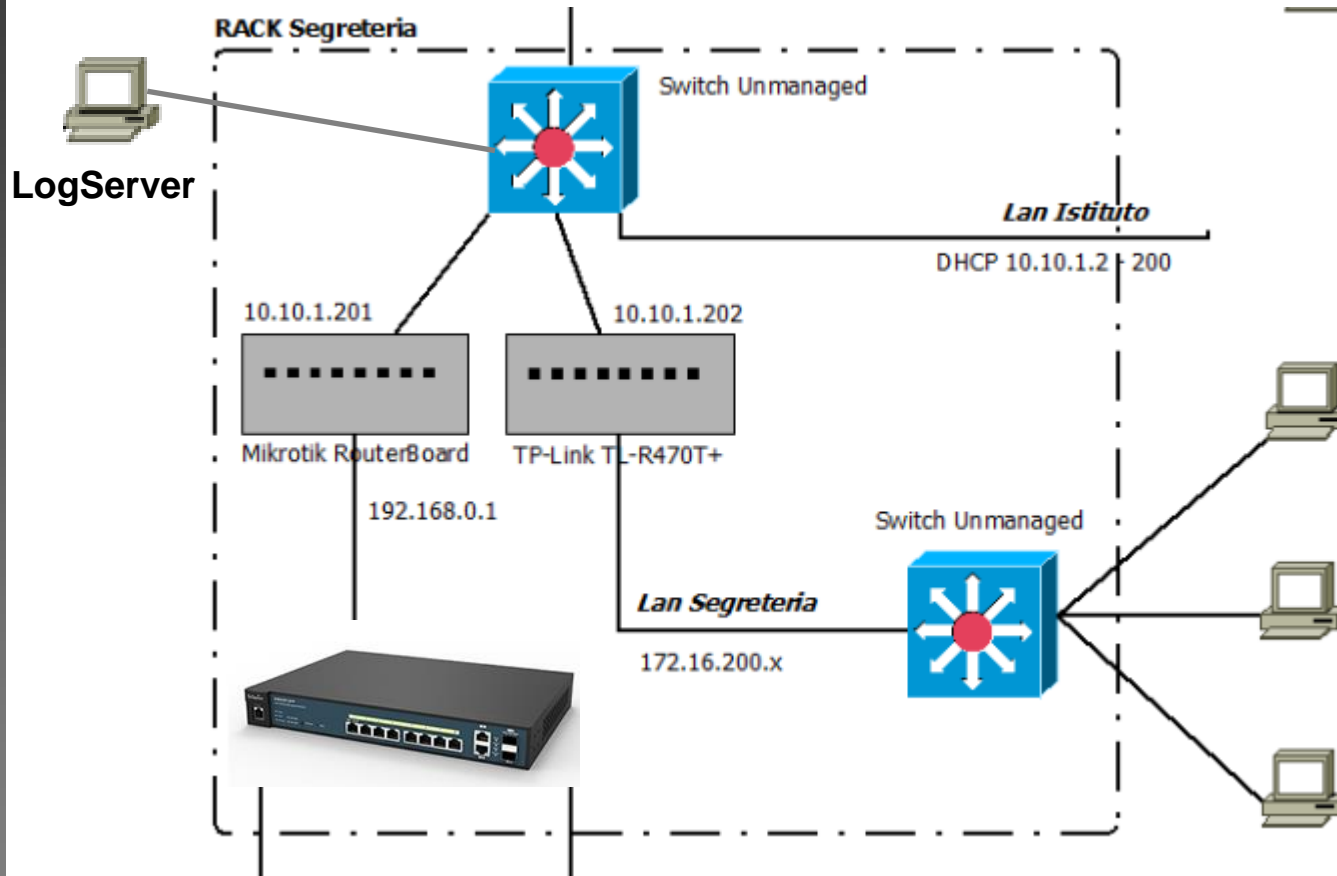

Topics

- Chi Siamo
- Esempi
- Ambiti
- Funzioni

# Esempio topologia Zoom 3

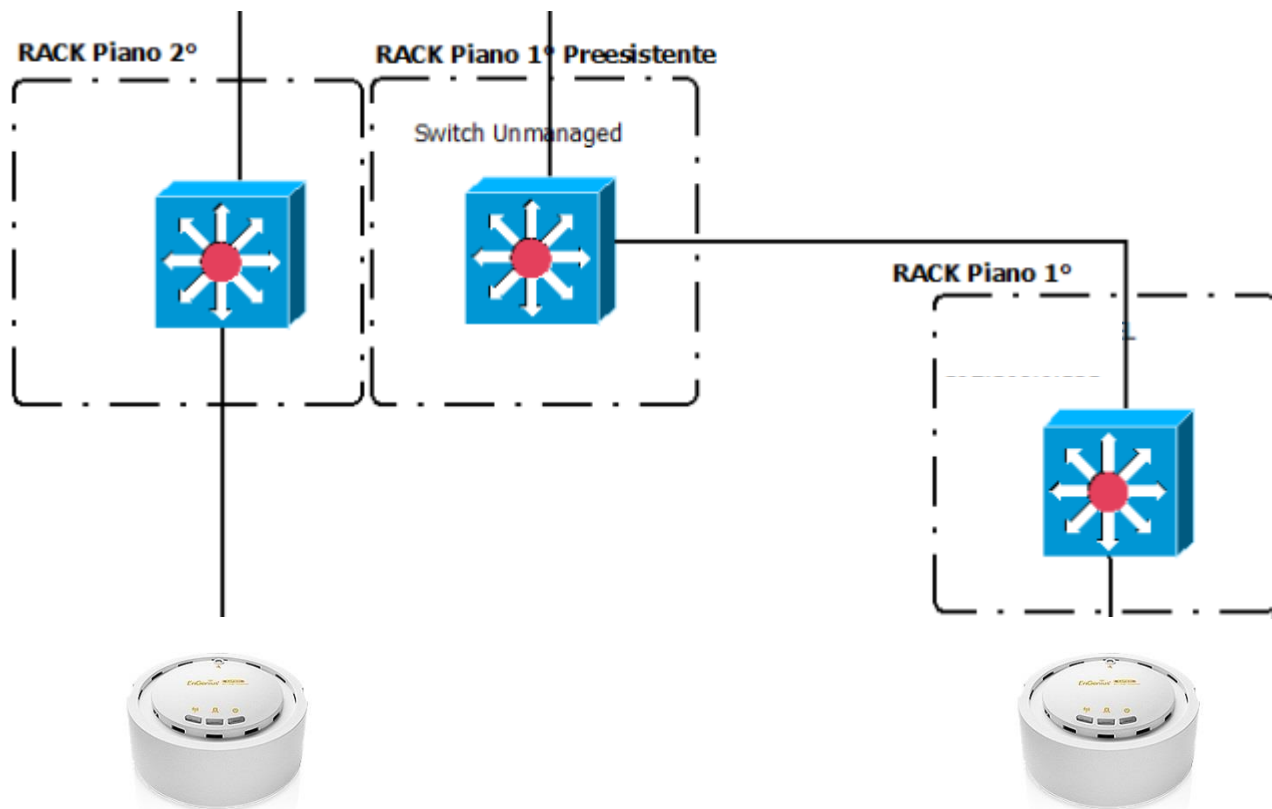

Topics

Chi Siamo  
Esempi  
Ambiti  
Funzioni





# Ambiti applicativi



Topics

- Chi Siamo
- Esempi
- Ambiti
- Funzioni



ecc, ecc

# Funzionalità 1

- Reindirizzamento delle connessioni wifi e cablate alla splash page.
- Splash page personalizzata e dotata di campi per inserire credenziali di login.

## Topics

Chi Siamo  
Esempi  
Ambiti  
Funzioni

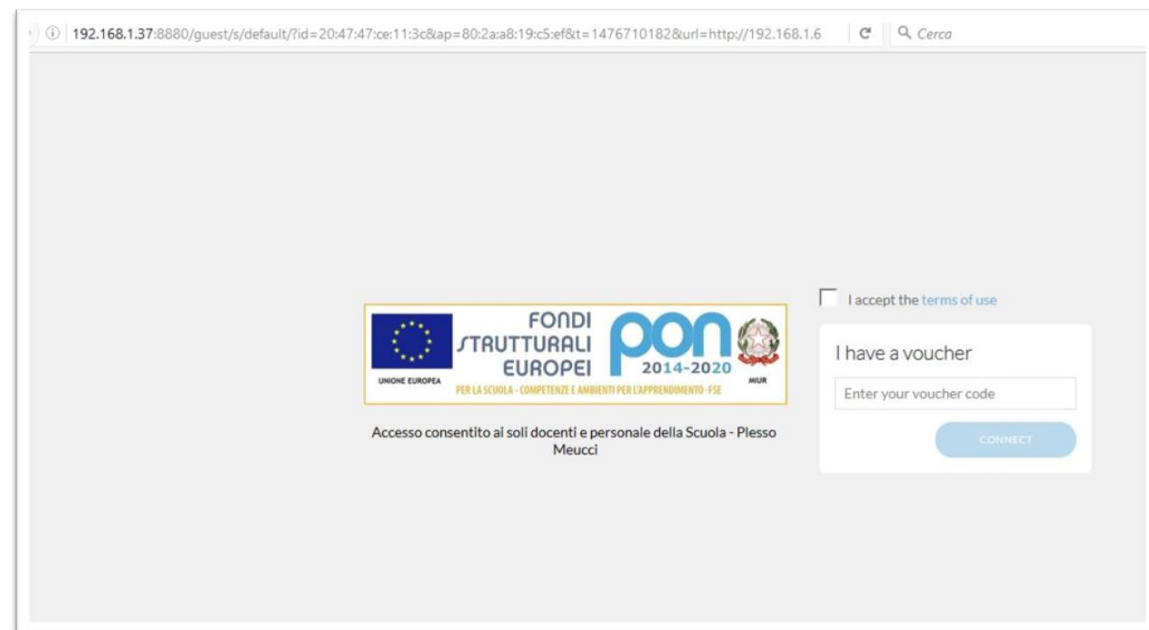

# Funzionalità 2

- Separazione traffico a Scuola:
  - Amministrazione,
  - Docenti,
  - Alunni,
  - Laboratori
  - ecc

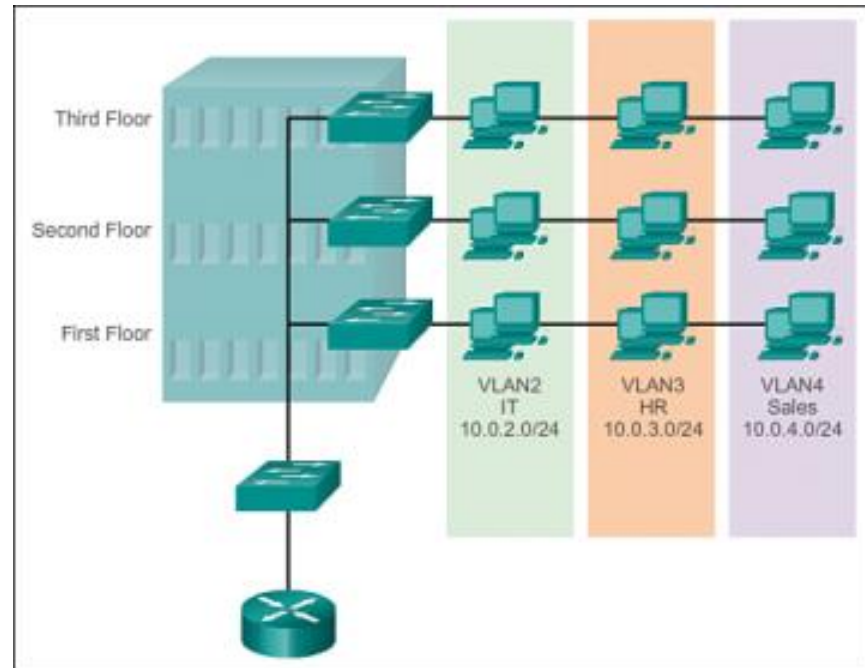

Topics

Chi Siamo  
Esempi  
Ambiti  
Funzioni

# Funzionalità 3

- Raccolta dei log e tracciamento delle sessioni per proteggere il titolare della connettività:
  - Quale IP ha visitato quel sito quel giorno a quell'ora?
  - Quale utente o device aveva quell'ip in quel momento?

## Topics

Chi Siamo  
Esempi  
Ambiti  
Funzioni

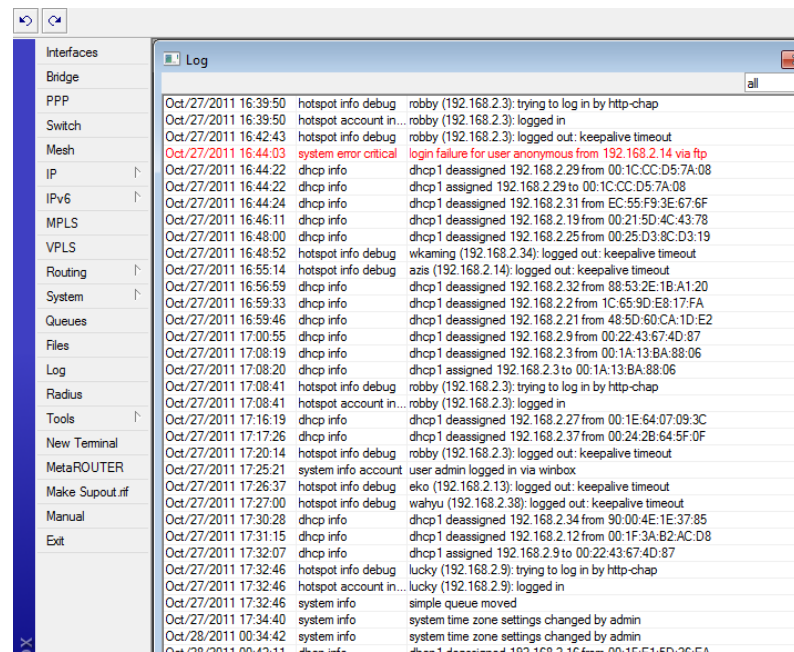

Timestamp	Level	Message
Oct/27/2011 16:39:50	debug	hotspot info debug robby (192.168.2.3): trying to log in by http-chap
Oct/27/2011 16:39:50	info	hotspot account in... robby (192.168.2.3): logged in
Oct/27/2011 16:42:43	debug	hotspot info debug robby (192.168.2.3): logged out: keepalive timeout
Oct/27/2011 16:44:03	critical	system error critical login failure for user anonymous from 192.168.2.14 via ftp
Oct/27/2011 16:44:22	info	dhcp info dhcp1 deassigned 192.168.2.29 from 00:1C:CC:D5:7A:08
Oct/27/2011 16:44:22	info	dhcp info dhcp1 assigned 192.168.2.29 to 00:1C:CC:D5:7A:08
Oct/27/2011 16:44:24	info	dhcp info dhcp1 deassigned 192.168.2.31 from EC:55:F9:3E:67:6F
Oct/27/2011 16:46:11	info	dhcp info dhcp1 deassigned 192.168.2.19 from 00:21:50:4C:43:78
Oct/27/2011 16:48:00	info	dhcp info dhcp1 deassigned 192.168.2.25 from 00:25:D3:8C:D3:19
Oct/27/2011 16:48:52	debug	hotspot info debug wkaming (192.168.2.34): logged out: keepalive timeout
Oct/27/2011 16:55:14	debug	hotspot info debug azis (192.168.2.14): logged out: keepalive timeout
Oct/27/2011 16:56:59	info	dhcp info dhcp1 deassigned 192.168.2.32 from 88:53:2E:1B:A1:20
Oct/27/2011 16:59:33	info	dhcp info dhcp1 deassigned 192.168.2.2 from 1C:65:9D:E8:17:FA
Oct/27/2011 16:59:46	info	dhcp info dhcp1 deassigned 192.168.2.21 from 48:5D:60:CA:1D:E2
Oct/27/2011 17:00:55	info	dhcp info dhcp1 deassigned 192.168.2.9 from 00:22:43:67:4D:87
Oct/27/2011 17:08:19	info	dhcp info dhcp1 deassigned 192.168.2.3 from 00:1A:13:BA:88:06
Oct/27/2011 17:08:20	info	dhcp info dhcp1 assigned 192.168.2.3 to 00:1A:13:BA:88:06
Oct/27/2011 17:08:41	debug	hotspot info debug robby (192.168.2.3): trying to log in by http-chap
Oct/27/2011 17:08:41	info	hotspot account in... robby (192.168.2.3): logged in
Oct/27/2011 17:16:19	info	dhcp info dhcp1 deassigned 192.168.2.27 from 00:1E:64:07:09:3C
Oct/27/2011 17:17:26	info	dhcp info dhcp1 deassigned 192.168.2.37 from 00:24:2B:64:5F:0F
Oct/27/2011 17:20:14	debug	hotspot info debug robby (192.168.2.3): logged out: keepalive timeout
Oct/27/2011 17:25:21	info	system info account user admin logged in via winbox
Oct/27/2011 17:26:37	debug	hotspot info debug eko (192.168.2.13): logged out: keepalive timeout
Oct/27/2011 17:27:00	debug	hotspot info debug waihyu (192.168.2.38): logged out: keepalive timeout
Oct/27/2011 17:30:28	info	dhcp info dhcp1 deassigned 192.168.2.34 from 90:00:4E:1E:37:85
Oct/27/2011 17:31:15	info	dhcp info dhcp1 deassigned 192.168.2.12 from 00:1F:3A:B2:AC:D8
Oct/27/2011 17:32:07	info	dhcp info dhcp1 assigned 192.168.2.9 to 00:22:43:67:4D:87
Oct/27/2011 17:32:46	debug	hotspot info debug lucky (192.168.2.9): trying to log in by http-chap
Oct/27/2011 17:32:46	info	hotspot account in... lucky (192.168.2.9): logged in
Oct/27/2011 17:32:46	info	system info simple queue moved
Oct/27/2011 17:34:40	info	system info system time zone settings changed by admin
Oct/28/2011 00:34:42	info	system info system time zone settings changed by admin

# Funzionalità 4

- Predisposizione creazione voucher via web
  - I voucher sono permessi di navigazione con limitazioni temporali, di banda o di traffico totale. Generazione format di stampa dei voucher.

KANGNDO HOTSPOT VOUCHER		
PAKET	Speed	Data
5000	Up to 1Mbps	Unlimited
Time	Validity	Price
5h	5d	Rp 5000.00
Username		Password
wre8k8		nryzk9
Call: 082 324 660 655		

- Abilitazione alla navigazione su determinati siti senza necessità di login sulla splash page
  - Esempio: il sito web aziendale (della scuola, dell'albergo, ecc)

## Topics

Chi Siamo  
Esempi  
Ambiti  
Funzioni

# Funzionalità 4

- Profilazione degli utenti wifi con limitazione di:
  - velocità di navigazione (banda),
  - quantità di traffico disponibile,
  - durata dell'account,
  - fasce orarie in cui si può navigare.

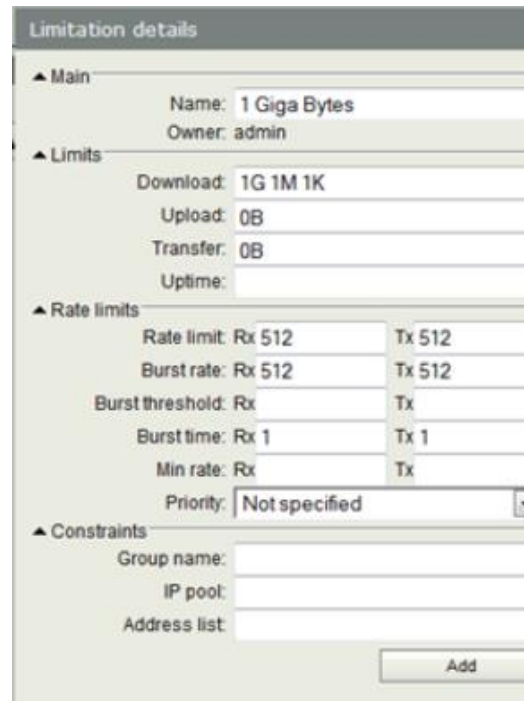

Limitation details

▲ Main  
Name: 1 Giga Bytes  
Owner: admin

▲ Limits  
Download: 1G 1M 1K  
Upload: 0B  
Transfer: 0B  
Uptime:

▲ Rate limits  
Rate limit: Rx 512 Tx 512  
Burst rate: Rx 512 Tx 512  
Burst threshold: Rx Tx  
Burst time: Rx 1 Tx 1  
Min rate: Rx Tx  
Priority: Not specified

▲ Constraints  
Group name:  
IP pool:  
Address list:

Add

Topics

Chi Siamo  
Esempi  
Ambiti  
Funzioni



**Roberto Franzese**

**Elmetel srl**

**Grazie**

**roberto.franzese@elmetel.it**